

MAIN BOARD

REVISION RECORD			
LT#	ECO NO.	APPROVED	DATE

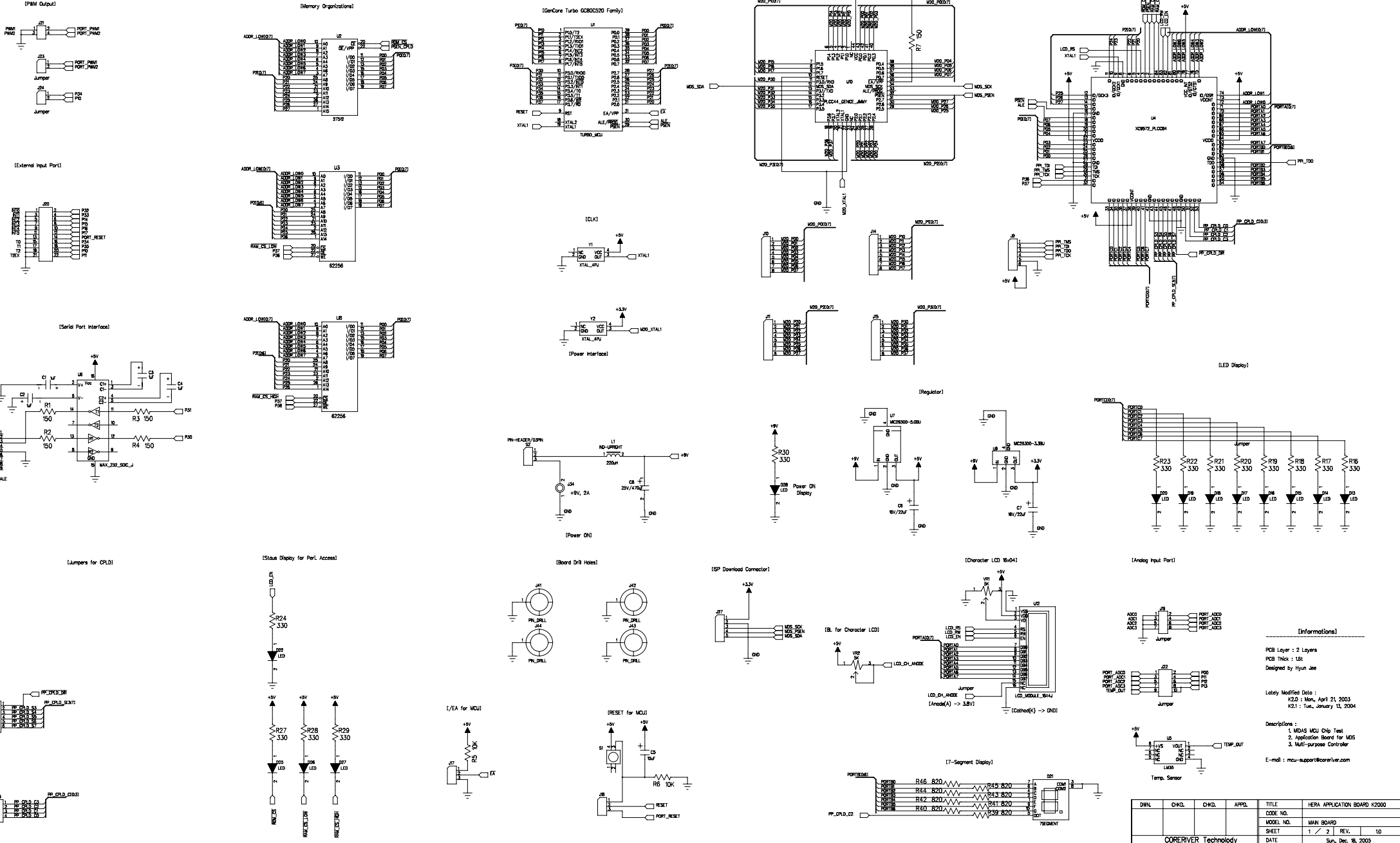

Informational

PCB Layer : 2 Layers
 PCB Thick : 16μ
 Designed by Hyun Jee

Latest Modified Date :
 K20 : Mon, April 21, 2003
 K21 : Tue, January 13, 2004

Descriptions :
 1. MDA5 MCU Chip Test
 2. Application Board for MDS
 3. Multi-purpose Controller

E-mail : mca-support@coreriver.com

DRAWN	CHKD.	CHKD.	APPRD.	TITLE
				HERA APPLICATION BOARD K2000
				CODE NO. MAIN BOARD
				SHEET 1 / 2 REV. 1.0
				DATE Sun, Dec 18, 2005

SUB BOARD

REVISION RECORD			
LT#	ECO NO.	APPROVED	DATE

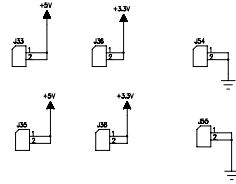
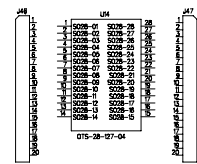
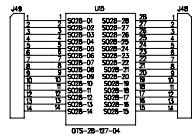
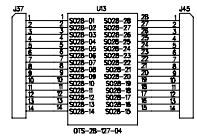

Bypass Capacitor!

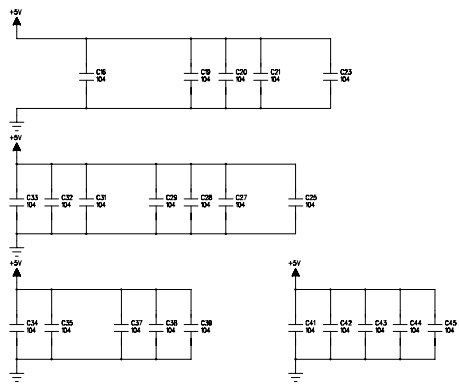

TEST BOARD

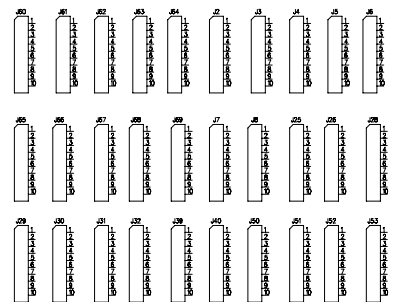

Lotay Modified Date:
Mon, April 21, 2003

DRAWN	CHKD.	CHKD.	APPD.	TITLE	HERA APPLICATION BOARD K2.0
				CODE NO.	
				MODEL NO.	SUB BOARD 1 / 1
				SHEET	2 / 2 REV. 1.0
GenCore Technology				DATE	Fri., April 18, 2003